



Agricultural Extension Service
The University of Tennessee



PB 1475

Grape Growing in Tennessee

Table of Contents

Introduction _____	3
Types of Grapes _____	3
Site Selection _____	4
Soils _____	4
Propagation _____	4
Planting	
Time to plant _____	5
Purchasing vines _____	6
Spacing _____	6
Preplant care _____	7
Planting _____	7
Pruning and Training	
Terminology _____	8
Trellis design and construction _____	8
Training systems _____	11
Pruning at planting _____	11
Vertical trellis systems:	
4-cane kniffin _____	11
umbrella kniffin _____	14
Hudson River umbrella _____	14
bilateral cordon _____	14
Horizontal trellis systems:	
Geneva double curtain _____	16
Pruning bearing vines _____	16
Balanced pruning _____	16
Time to prune _____	18
Trunk renewal _____	19
Pruning neglected vines _____	19
Disposal of prunings _____	20
Fertilizing and Liming _____	20
Vineyard Floor Management _____	21
Pest Control _____	23
Estimating Yields in Vineyards _____	23
Harvesting _____	25
Storage _____	26
Additional References _____	26

Diagram Title

Diagram#

Grapevine Propagation from Cuttings _____	1
Grapevine Propagation from Layering _____	2
Suggested Spacings for Grapevines _____	3
Planting an Own-rooted Grapevine _____	4A
Planting a Grafted Grapevine _____	4B
Vertical Trellis Design _____	5
High-Head Bilateral Cordon Trellis _____	6A
Low-Head Bilateral Cordon Trellis _____	6B
Geneva Double Curtain (GDC) Trellis _____	7
2-Wire Vertical Trellis _____	8
End Post and Brace for a Single-Wire Trellis _____	9
Common Training Systems for Grapes _____	10
Pruning and Training, First Year _____	11
4-Cane Kniffin System _____	12
Vertical Trellis Systems, First Dormant Pruning _____	13
4-Cane Kniffin System, Mature Vine _____	14
Umbrella Kniffin System _____	15
Hudson River Umbrella System _____	16
Bilate Cordon System, First Dormant Pruning _____	17
Spur Pruning Grapevines _____	18
Geneva Double Curtain (GDC) Training _____	19
New Wood Versus Old Wood on Grapevines _____	20
Cross Section of a Compound Bud of Concord _____	21
Trunk Renewal _____	22
Vineyard Floor Management _____	23



Grape Growing in Tennessee

David W. Lockwood, Professor
Darren K. Robinson, Assistant Professor
Plant and Soil Science

Introduction

Grapes may be grown in all parts of Tennessee. However, not all types of grapes or varieties of grapes are adapted to all parts of the state. With proper attention to selection of the correct type and variety of grapes, site selection and reasonable cultural practices, grapes can be a viable crop for both commercial and hobby growers. The development of commercial wineries and the introduction of several seedless grape varieties adapted to Tennessee growing conditions have contributed to grape production becoming an increasingly important part of Tennessee's agricultural economy.

Types of Grapes

Several different types of grapes are grown in the United States. Each type has characteristics that may make it more or less desirable than others in terms of adaptability and use of the fruit.

American grapes used for fruiting are usually one of two species; *Vitis labrusca* (i.e. Concord, Niagara) or *Vitis aestivalis* (i.e. Norton, Delaware). American varieties tend to be more adapted to Tennessee growing conditions than the other types. Fruit from these varieties is widely used for juice, wine, preserves and fresh consumption.

Several **seedless** grape varieties have been developed. They do not yield as heavily as seeded American varieties. However, they do offer potential for fresh fruit sales.

French-American hybrid varieties are crosses between European varieties and certain wild species found in America. Fruit from the "hybrids" is used primarily for wine. Varieties include Seyval, Vidal, Foch, DeChaunac, Chambourcin and Chancellor. Many of the hybrid varieties will perform as well as several of the American bunch varieties.

Muscadine grapes (*Vitis rotundifolia*) grow well in many parts of the Southeast. Unfortunately, cold injury to cordons and trunks can be a fairly common occurrence in most parts of Tennessee. Therefore, commercial muscadine grape production is not suggested for most parts of the state. Fruit from muscadine vines is used for juice, wines, processing and fresh consumption.

Vitis vinifera (European grape) varieties, such as Chardon-

nay, and Cabernet Sauvignon tend to be less winter-hardy and more subject to fungal diseases than either American grapes or French-American hybrids. Expect lower yields and less consistent production with viniferas than other types of grapes. They should only be grown in the most desirable sites and with the best cultural practices. Due to the likely presence of root phylloxera, *V. vinifera* varieties should be grafted onto phylloxera-resistant rootstocks. While test plantings of viniferas are encouraged, extensive plantings are not suggested for Tennessee at this time.

Many grape varieties, in addition to those listed above, are also available. Refer to Extension PB 746, "**Tree Fruit, Tree Nut and Small Fruit Cultivars for Tennessee,**" for more suggestions.

Site Selection

While grapes may be grown under a wide variety of conditions, certain factors may make one site more desirable than another.

Areas elevated above their immediate surroundings offer some protection from frosts and diseases. Injury to buds or new growth due to frost becomes more likely the closer you get to the basal part of a slope. Likewise, fogs keep foliage and fruits wet, thus increasing the potential for certain diseases. By establishing the vineyard higher up the slope, both frost and disease pressure may be lessened. The very top of a hill may not be the most desirable spot, however, as wind damage and winter freeze injury are apt to become more of a problem.

Direction of slope may have some impact on vineyard performance. Vines on a north to north-eastern slope tend to be less prone to winter damage and spring frost injury than those on a slope with some southern orientation. Vineyards on an eastern-facing slope may have less disease pressure than on other slopes, since the morning sun dries off fruits and foliage earlier on the eastern slope, thereby lessening the chances for disease development.

Grapevines should be planted where they will receive full sun. Shade will cause plants to become "leggy." These elongated, spindly shoots will produce fewer fruiting sites with poorer quality fruit that are more prone to disease problems.

Soils

Grapevines can be deep-rooted in certain soils. Ideally, vines need a minimum of 24 to 36 inches of rooting depth before encountering an impervious layer, such as rock or a hardpan. The deeper and more extensive the root system, the more capable the vine will be to withstand stresses such as drought, low fertility and low soil temperatures.

While water is essential for growth and production, grapevines will not tolerate excessive soil moisture, especially during the growing season. Sites with poor internal and/or surface drainage characteristics should either be modified to solve the problem or avoided. Irrigation is desirable on excessively droughty soils. Grapes do not require highly fertile soils. In fact, such soils are undesirable, since growth may be excessive, causing shaded, poor-quality fruit and increased disease pressure. For soils with low to moderate fertility levels, a liming and fertilization program may be devised that will give a balance between vegetative growth and fruiting. Knowledge of soil characteristics before planting is valuable in determining the best vine spacing and trellis system to use.

Propagation

Grapevines may be successfully propagated by several methods. It may be possible to propagate your own plants if existing vines are healthy and if proper procedures are followed. If these criteria are not met, rooting success and subsequent plant growth will be

poor, creating a delay in developing a productive vineyard.

Most grapevines, with the exception of *V. vinifera* varieties, are grown on their own roots. *V. vinifera* varieties are especially sensitive to root phylloxera, which is a threat throughout the country. Therefore, these vines are grafted onto resistant rootstocks (*Diagrams 4A and 4B, Own-rooted vs. Grafted Vines*).

American bunch varieties and French-American hybrid varieties may be propagated by cuttings. Cuttings should be taken in early to midwinter from healthy, well-matured canes. The ideal cuttings are about 1/4 to 3/8 inch in diameter and three to four nodes in length (*Diagram 1*). The bottom cut should be made just below the basal bud. The top cut should be made about 1 inch above the top bud.

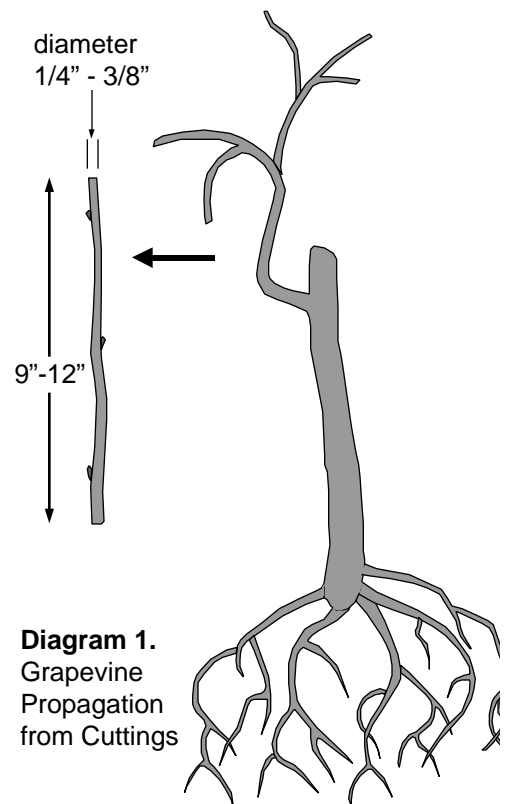

Cuttings should be grouped into bundles of uniform lengths with the top ends together. Bundle each variety separately. Bundles may be moistened, put in plastic bags, sealed and held in refrigerated storage (keep from freezing) or buried in a trench with the basal ends up and covered with several inches of soil and/or mulch. The trench should be well-drained. If a protective structure such as a greenhouse is available, cuttings can be set immediately without the need for storage.

The area in which the cuttings will be placed should be free of weeds and worked 10 to 12 inches deep. Irrigation is highly desirable.

Once the danger of frost is past, cuttings may be set in the nursery. Place the cuttings about 6 inches apart in the trench, with all buds except the top one below soil level. Backfill the trench and firm the soil around the cuttings.

Keep the nursery rows free of weeds throughout the growing season. Control of insects and diseases is essential to maximize growth. Carefully monitor moisture levels and water when necessary. Fertilization is not needed in most cases and is definitely not recommended in the early stages of growth, as fertilizer burn may occur to tender, new roots. If fertilizer is used during the growing season, keep it several inches away from the base of the cuttings. Use about ounce of 10-10-10 fertilizer or its equivalent per linear foot of nursery row. Do not fertilize after mid-July.

Cuttings should be held in the nursery row until dormant. At that

time, they may be dug, stored under moist conditions at about 34 F. until planting time or transplanted directly from the nursery row to the vineyard at the appropriate time.

Layering is the surest way to propagate all grape varieties. However, it is seldom used except for varieties that do not root readily from cuttings, such as with muscadines and Cynthiana. Layering is also the preferred technique to fill vacancies in established vineyards where vines are growing on their own roots, since young vines remain attached to the mother vine until well-established.

To layer a grapevine, dig a hole 10 to 15 inches deep where the new vine is desired. This location must be close enough to the mother vine so it can be reached by a long cane. Select a cane on the mother vine and prune it to a length about 3 feet greater than the distance between the vine and the hole. Extend the long cane to the bottom of the hole, then bend it vertically upward so that at least two buds remain above the soil once the hole is refilled.

Strip off developing shoots on the long cane between the mother vine and the soil. Shoots arising from nodes above the soil line on the tip of the long cane should be retained. Do not allow the layered plant to fruit for two years.

Do not separate the layered vine from the mother vine until the diameter of the trunk of the new vine is greater than that of the wood leading to it from the mother vine. This would indicate the young vine has a functional root system and no longer is dependent on the mother vine. (*Diagram 2*).

Grafting, including budding, is a fairly technical procedure. The specific type of graft to be used will depend on the size of the vine being topworked and the time of year in which it will be done. Additional information on grapevine propagation may be obtained at your county Extension office.

Planting

Time to plant

The ideal time to plant bare-root grapevines in Tennessee is in late winter to early spring (mid-February to early April). Vines

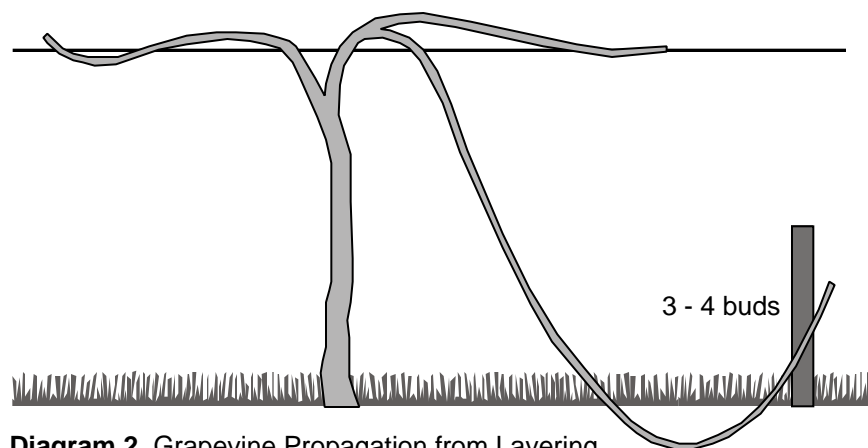

Diagram 2. Grapevine Propagation from Layering

planted in fall or early winter may suffer root injury or death in the event of a prolonged cold period shortly after planting. If planting later than early April, hot, dry conditions may occur that could reduce plant growth or even cause plant death.

Purchasing vines

Since vineyard establishment can be fairly expensive, and since a properly maintained vineyard will live and fruit for many years, it is very important to purchase healthy plants of the correct variety. Therefore, purchase plants from reputable nurseries. As long as the vines are properly cared for in the nursery and during shipping, it is not necessary to purchase them from local nurseries. Vigorous, one-year-old plants are best. Once plants are received, take care to prevent roots from drying out, freezing or overheating.

The number of plants needed to supply fruit will vary considerably, depending on the use of the fruit and the number of people who will be consuming it. Calculate the number of vines needed based on the assumption that each mature plant will yield about 15 pounds of fruit (25 to 35 pounds for a mature muscadine vine) and that about 15 to 20 pounds of fruit are required to give about one gallon of juice. Realize that these figures are only rough estimates and that several factors may influence them.

Spacing

Space grapevines about 8 feet apart in the rows. This spacing may need to be increased to about 10 feet for vigorous varieties set on fertile soils, or reduced to 6 feet for weak-growing varieties planted on less-fertile soils. For muscadines, a spacing of 16 to 20 feet apart in rows is suggested. The distance between rows will depend on the size of the equipment being used to maintain the vineyard, the lay of the land (extra distance between rows may be needed on steeper slopes) and the type of trellis constructed to support the vines. Commercial grape growers generally

space rows 10 to 12 feet apart. Do not space rows less than 6 feet apart, as mutual shading among rows may become a problem.

(Diagram 3. Suggested Spacings for Grapevines). Table 1 shows the number of vines needed per acre at several in-row and between-row spacings. To calculate the number of vines needed per acre, multiply the distance between vines in a row by the distance between rows to find the square feet of space for each vine. Divide this number into 43,560 (the number of square feet in an acre) to get the number of vines per acre.

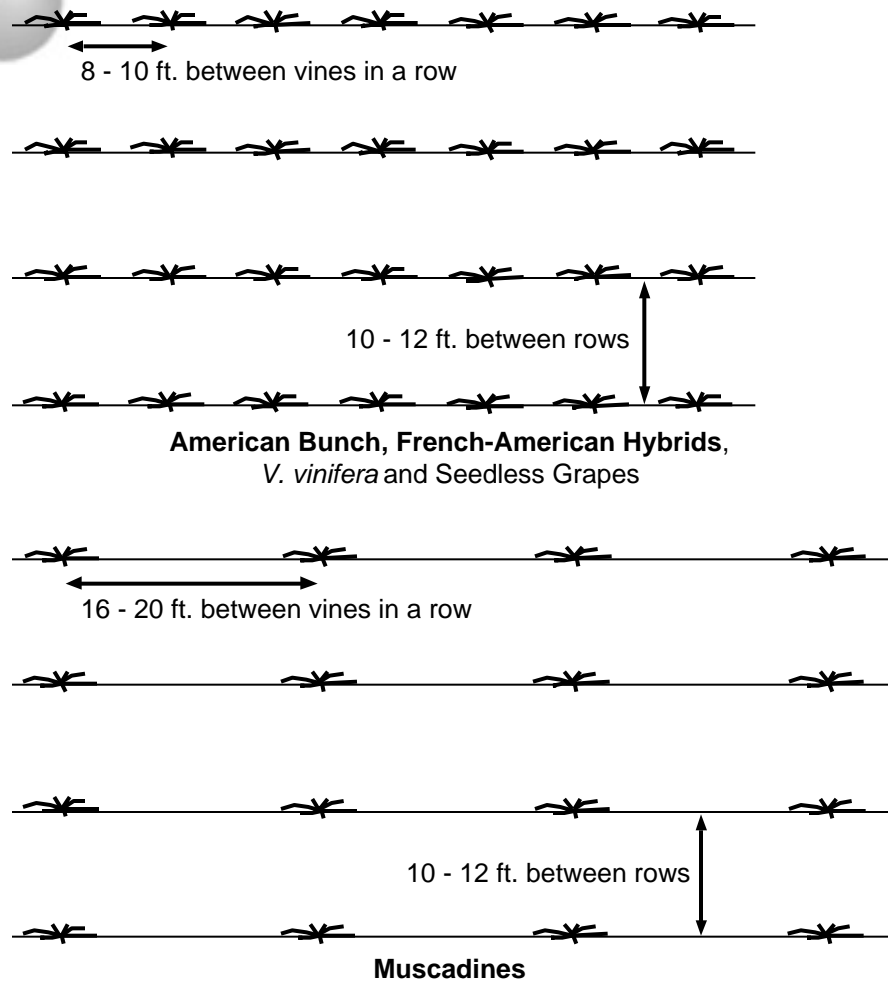

Diagram 3. Suggested Spacings for Grapevines

Table 1. Number of Vines per Acre				
		Distance between rows		
		8 feet	10 feet	12 feet
Distance between vines in a row	6 feet	907	726	605
	8 feet	680	544	453
	10 feet	544	435	363
	16 feet	340	272	226
	20 feet	272	217	181
	vines/acre			

Example: 8 feet between vines in a row x 10 feet between rows = 80 square feet per vine. Divide 80 into 43,560 to get 544.5 vines per acre (round off to 544 vines.)

Preplant vine care

Inspect vines upon receipt to be sure the roots have not dried out, frozen or overheated. Healthy roots should feel firm, not spongy or hard and brittle when squeezed. You should be able to bend the roots some without breaking them. Cutting through the exterior of a root should reveal white tissue. If the interior of the root is tan to brown, the roots have been damaged and plant survival is apt to be poor.

Store vines in a cool area. Take care to prevent the roots from drying out, freezing or becoming too hot. If properly stored, vines may be kept in the shipping bundle for several weeks before planting.

Soak vine roots in water for a couple of hours prior to planting. Take care to prevent the roots from drying out during planting.

Planting

Inspect the root system before planting. Prune off broken, dead, diseased or insect-infested roots. Do not prune the root system any more than is absolutely necessary.

Grapevines propagated from cuttings or layering should be planted as deep as they were set in

the nursery. Dig holes deep enough and wide enough to accommodate the root system without having to bend roots to fit (*Diagram 4A. Planting an Own-Rooted Grapevine*). Grafted grapevines should be set with the graft union just above the soil line (*Diagram 4B*). Set the vine in the hole, spread out the root system and work soil in around the roots to eliminate air pockets. Once the soil has covered the root system, tamp it down to further assure good root/soil contact. If the soil is dry, pour water in the hole before completely filling the hole. Fill the hole with soil to the same level or slightly higher than the surrounding ground. If a depression in the soil is left at planting, it should be filled before going into the first dormant season. Freezing and thawing of water in direct contact with the trunk could damage it.

DO NOT add soil amendments such as peat moss, sawdust or manure to the soil being used to backfill the hole. Such a practice

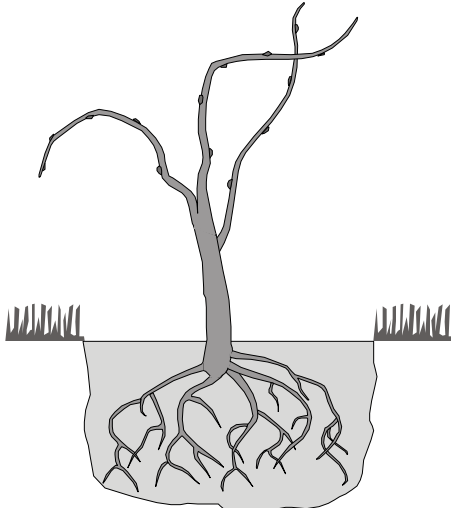

Diagram 4A. Planting an Own-Rooted Grapevine

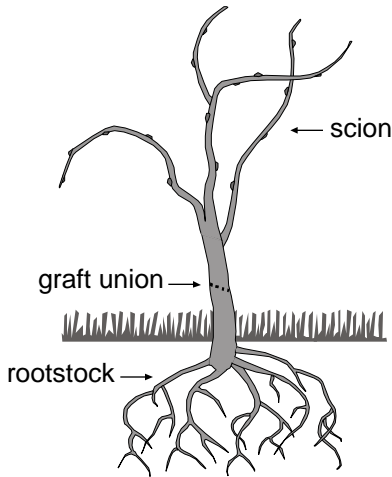

Diagram 4B. Planting a Grafted Grapevine

creates a “flower-pot” effect, which discourages root growth into the surrounding soil. The more restricted the root system of the grapevine, the more susceptible the vine will be to drought, flooding or improper fertility. Do not put fertilizer in the hole because plant roots may be injured or killed by direct contact with high amounts of certain fertilizer materials.

Pruning and Training Grapevines

Pruning and training are two separate practices that play very important roles in the development and maintenance of grapevines. They influence light distribution throughout the canopy, which greatly affects yields, fruit quality and pest problems. Ease of management of the vines and the crop will be impacted by pruning and training practices. Support wires on the trellis should be set at a height that will make pruning, cluster thinning and harvest more convenient.

Early in the life of the vineyard, pruning and training are used together to build a vine of the desired size and shape. Once the vine has filled its allotted space on the trellis, annual pruning is used to renew fruiting wood, to promote uniform light distribution throughout the canopy and to keep the vine from overgrowing neighboring vines. Pruning and training are parts of an integrated vineyard management system in which each practice has an influence on the success of all other cultural practices and on the overall crop.

Terminology

Arms — major branches of the trunk on which canes or spurs are borne.

Cane — a mature, woody shoot after leaf drop.

Cordon — extension of a trunk, usually oriented horizontally along a wire. Fully developed cordons can bear spurs and canes. Cordons may extend in one or two directions from the trunk. They are retained for several years.

Pruning — removal of parts of a plant. It is done to regulate crop size and fruit quality. Pruning also is used to determine the quality, quantity and location of vegetative growth. The two basic types of pruning for grapes are 1) cane renewal (cane replacement), in which canes that fruited the previous year are removed and some canes that grew the previous year are selected for fruiting in the current year, and 2) spur pruning, where short canes that fruited the previous year are removed and replaced with spurs on the cordon as a site for fruiting and shoot growth the current year. Pruning should be done every year of the vine’s life.

Shoot — green growth from a bud on a cane, spur, cordon, arm or trunk. A shoot always bears leaves and tendrils and may also bear fruit. In the fall, a shoot matures and drops its leaves. It is then called a cane.

Spur — cane pruned to a few nodes (five or less). A renewal spur has one or two buds to produce canes at a particular location on an arm or cordon. A fruiting spur is chosen to produce fruiting shoots.

Training — development of the framework of the vine on the trellis. Training impacts exposure of fruit and foliage to light, as well as ease of management.

Trunk — the semi-permanent, above-ground, vertically-oriented stem of a vine.

Trellis Design and Construction

The trellis of a vineyard should be strong, long-lasting and require low maintenance. Its purpose is to support the foliage and fruit of vines, thus allowing good light interception and ease of management. Trellis construction represents a major investment in both time and money.

Two types of trellises are suggested for use in Tennessee vineyards. The **vertical trellis** uses two wires. The lower wire is situated at 3 feet aboveground to enhance good air circulation under the vines, and the top wire is at about 6 feet aboveground (*Diagram 5*). The vertical trellis is used for the four-cane Kniffin system, the umbrella Kniffin system and the Hudson River umbrella system. The **bilateral cordon system**, a variation of the vertical trellis, uses a single wire to support the cordons and the crop. This wire may be 6 feet aboveground for a high-head cordon system where new shoots grow down, or 3 feet in height for a low-head cordon system where new shoots grow up. Movable catch wires may be used to position shoots in either the downward (*Diagram 6A*) or upward (*Diagram 6B*) direction. A

Diagram 5.
Vertical Trellis Design

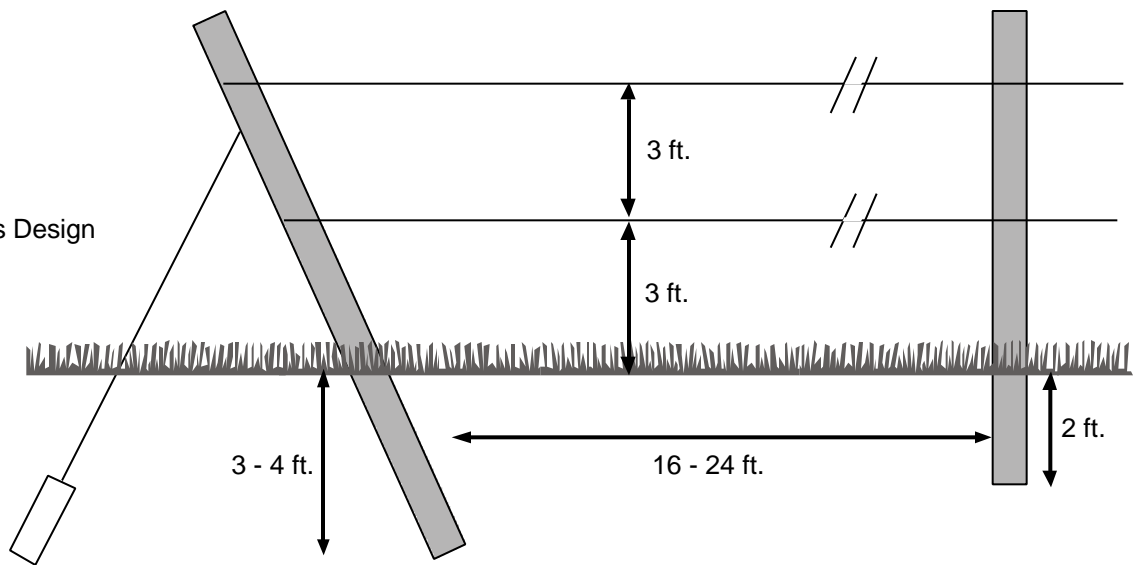

Diagram 6A.
High-Head Bilateral
Cordon System

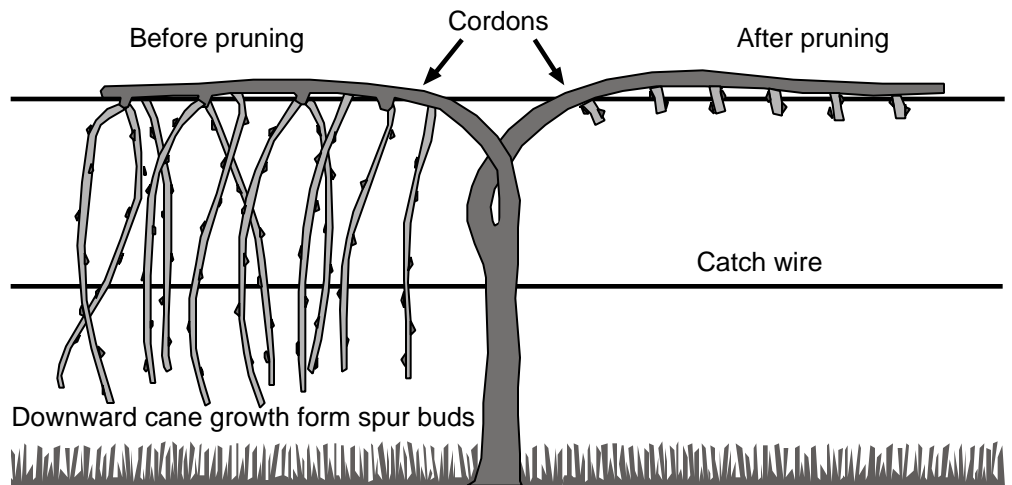
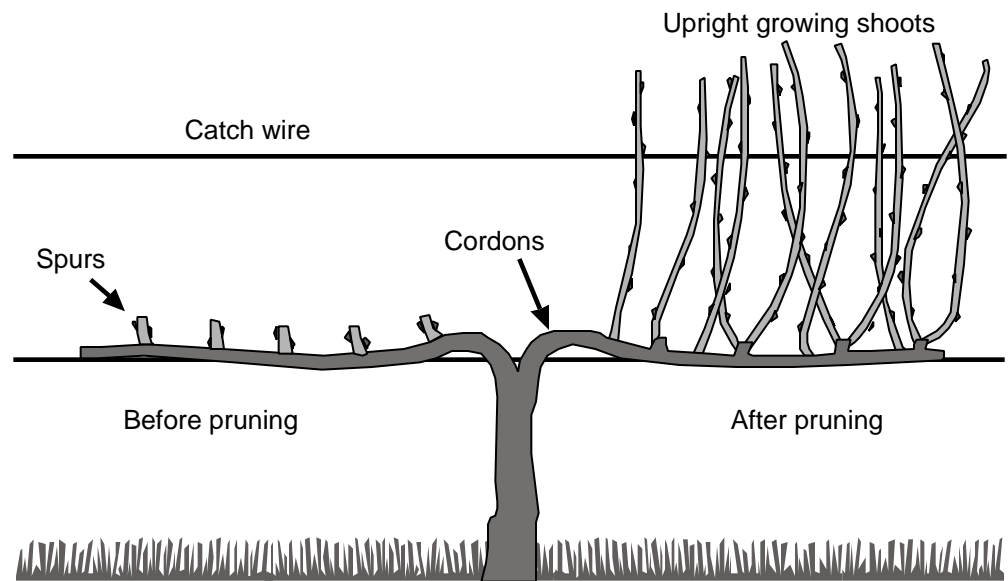

Diagram 6B.
Low-Head Bilateral
Cordon System



horizontal trellis is used for the Geneva double curtain (GDC) system (*Diagram 7*). This system uses three wires. One wire, attached to the posts about 3 feet above ground, is used for trunk support. Two parallel, horizontal wires attached to the ends of 4-foot long cross arms secured to posts at 6 feet aboveground hold the cordons or canes.

Descriptions of posts, anchors and wire needed for trellises reflect the needs in commercial vineyards. Limited plantings using only a few vines per row may not need such a heavily constructed trellis.

Posts should be long-lasting. Wood posts should be treated for in-ground use and should last up to 20 years.

Line posts should be at least 8 feet long. The posts should be set at least 2 feet in the ground and extend aboveground 6 feet or more. Line posts should have a top diameter of 3 inches or more. They should not be spaced more than 24 feet apart. Depending on vine spacing, two or three vines may be between line posts. Line posts are used to maintain the correct wire height in rows (*Diagram 8*).

End posts are used to maintain wire height. All wire tightening and tensioning is done from the end posts, so they need to be strong. End posts should be at least 10 feet long to allow them to be set 3 to 4 feet in the ground and still have at least 6 feet of post aboveground (*Diagram 8*). These posts should have a minimum top diameter of 4 inches. Larger end

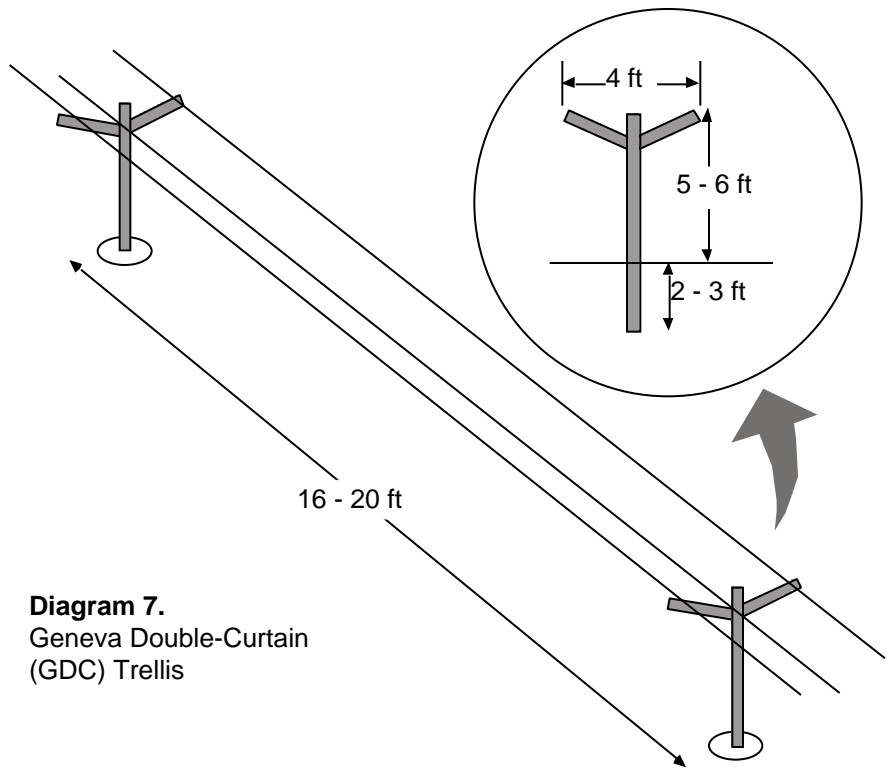

Diagram 7.
Geneva Double-Curtain (GDC) Trellis

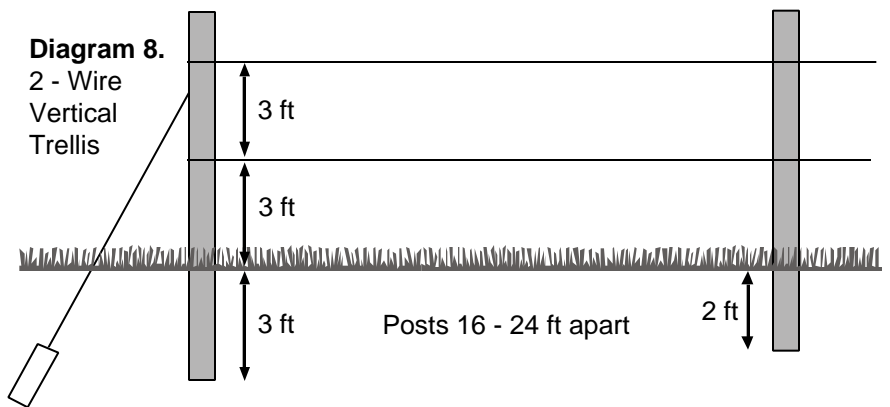

Diagram 8.
2 - Wire Vertical Trellis

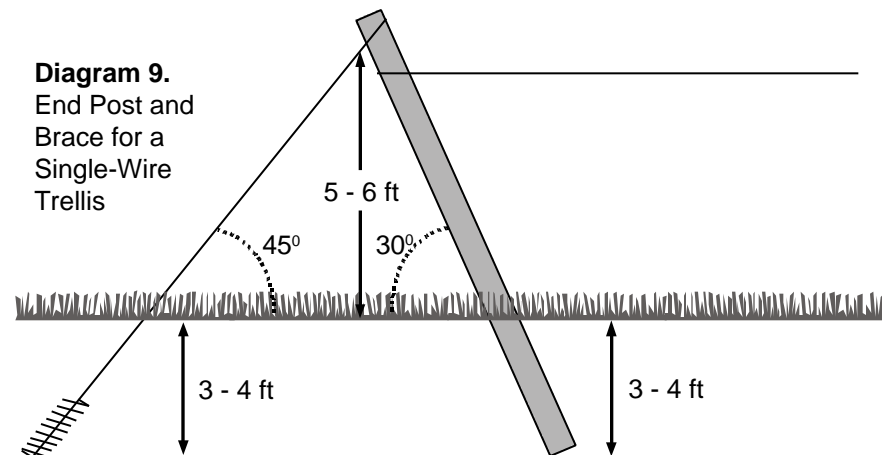

Diagram 9.
End Post and Brace for a Single-Wire Trellis

posts are suggested for Geneva double curtain trellises. The stability of an end post can be increased by setting or driving it so the aboveground part of the post is angled away from the vineyard at about 30 degrees from the vertical and braced or anchored (*Diagram 9*).

Many types of **braces or anchors** can be used. A screw-in anchor 4 to 6 inches in diameter works well. The anchor should be set 4 feet away from the base of the post and screwed in at a 45-degree angle toward the end post and aligned with the row. The anchor should go in the ground at least 4 feet.

The **wire** suggested to support the weight of the canes or cordons, foliage and the crop is a number 11, crimped, high-tensile (210,000 p.s.i.), steel wire with a class III galvanizing. Lower wires used for trunk support or for securing the ends of canes on some systems can be of a lower tensile strength. Uncrimped number 11 or 12 galvanized fence wire works well.

Wire may be secured to line posts by stapling it with a 1 to 1¹/₄-inch fence staple in the top or in the side 2 to 5 inches below the top or by drilling a hole in the line post 2 to 3 inches below the top and threading the wire through it. If using staples, be sure to not drive them in tight, as this could weaken the wire and also prevent tightening and retensioning the wire.

Taut wires are necessary to minimize sagging of cordons or canes, to reduce development of crooked trunks and to promote

good light penetration throughout the canopy of the vines. Cornell University recommends tensioning the wire to 250 to 300 pounds.

Training systems

Many different types of training systems are used in grapes. The following listing outlines conditions that might favor the use of a particular training system (*Diagram 10*):

1. 4-Cane Kniffin — use on low-vigor varieties so canes on the upper wire do not shade those on the lower wire.
2. Umbrella Kniffin — suggested for high-vigor varieties such as Concord, Niagara and Fredonia.
3. Hudson River Umbrella — use on vines having medium to high vigor.
4. Bilateral Cordon — use on vines of low to medium vigor.
5. Geneva Double Curtain — suggested for vines high in vigor.

Pruning at Planting

Regardless of the trellis system or training system being used, pruning and training of newly set vines is the same. New vines should be cut back to a single shoot. That shoot should be cut back to two buds prior to bud break to maximize shoot growth the first growing season. If the trellis has been constructed at the time of planting, loosely tie a string from the vine to the lower trellis wire and secure the new shoot to the string. This is important in developing a straight trunk, which promotes a stronger, more productive vine. If the trellis has not been

constructed by planting time, set a stake beside the vine and loosely secure the trunk to it as it grows (*Diagram 11*). If more than one shoot develops, pinch the tip out of all of them except the one selected to be the trunk. Trunk development is the prime consideration in training a new vine. For some types of grapes that tend to be more susceptible to cold injury, having two or more trunks may be advisable. On vines grown from rooted cuttings, the second trunk should originate at or below the ground line. For grafted vines, the second trunk should originate above the graft union. Ideally, the trunks should be of different ages to lessen the chance of cold injury damaging all the trunks. Trunks should be renewed about every 15 years. In cases of cold injury, mechanical damage or other problems, trunks may need to be renewed sooner.

Vertical Trellis Systems:

4-cane Kniffin system

The 4-cane Kniffin system (*Diagram 12*) uses fruiting canes on both the upper and lower wires. Wires should be 3 feet and 6 feet aboveground to facilitate good air, light and spray penetration throughout the canopy. With vigorous vines, the lower tier of canes can be heavily shaded, resulting in low production and poor-quality fruit. Where this problem arises, it is possible to convert to the umbrella kniffin system. If possible, orient rows on the 4-cane kniffin system north and south for the best performance.

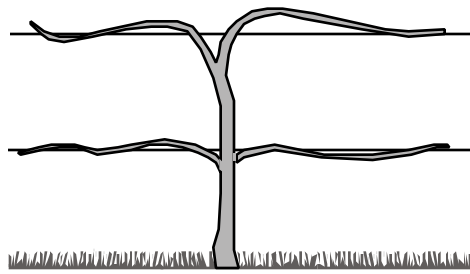

4-Cane Kniffin System

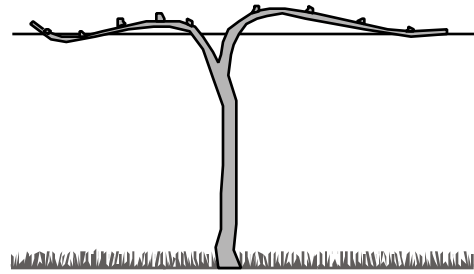

Bilateral Cordon System

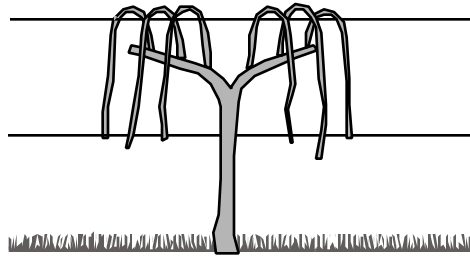

Umbrella Kniffin System

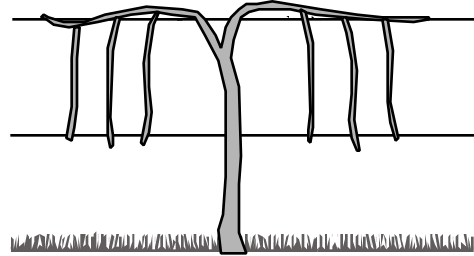

Hudson River Umbrella System

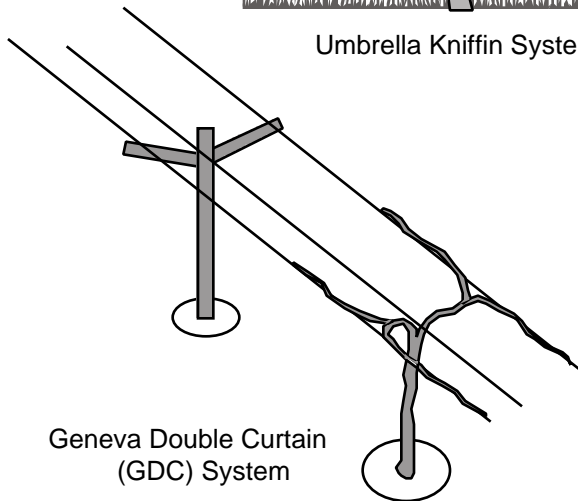

Geneva Double Curtain (GDC) System

Diagram 10.
Common Training Systems for Grapes

Diagram 11. Pruning and Training First Year

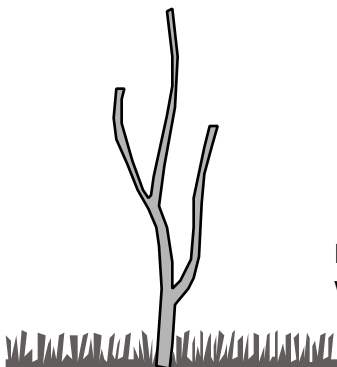

Prune to 1 shoot
with 2 buds

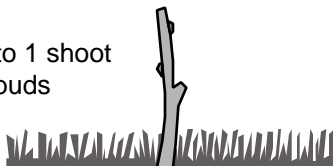

Loosely tie 1
new shoot to a
vertical stake

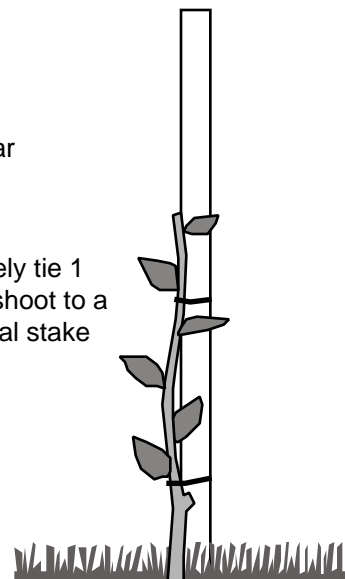

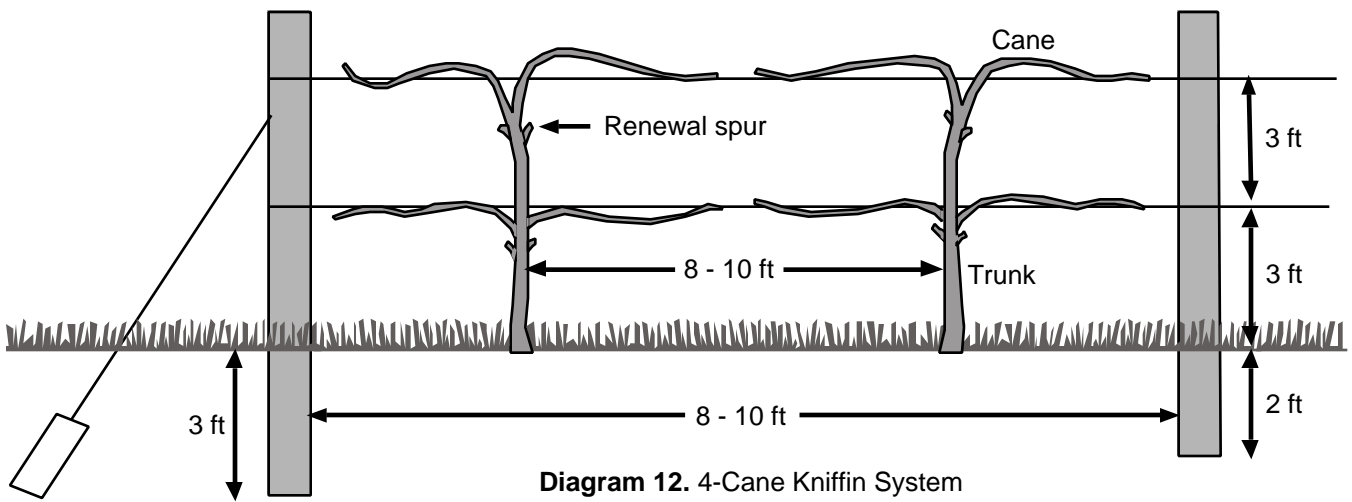

Diagram 12. 4-Cane Kniffin System

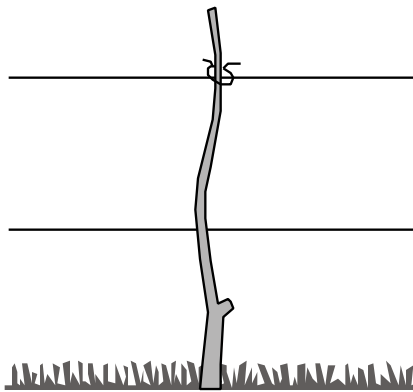

Diagram 13. Vertical Trellis Systems First Dormant Pruning

During the first dormant pruning (one year after planting), head the trunk about 4 inches above the upper trellis wire (Diagram 13). Lateral branching will result from the heading cut and canes that will fruit the following year can be selected. In some cases, sufficient trunk growth may occur to allow heading the trunk above the wire during the growing season. Eliminate all flower clusters, as the primary goal at this stage is to develop the vine and fruiting will reduce growth. During the next dormant pruning, canes can be trained to the upper and lower trellis wires on each side of the trunk.

Pruning mature vines (Diagram 14) involves the following steps:

1. Remove at the trunk all canes that bore fruit the previous year (old wood).
2. Select canes that grew the previous year (new wood) on each side of the trunk near both the upper and lower wires and train them to the wires. These canes will bear the next fruit crop.
3. Select four more canes from the previous year. Keep one on each side of the trunk for both the

upper and lower wires. Prune these canes back to two buds. They are called "renewal spurs." From them, shoots will grow. Some of these shoots will be selected using the above criteria for fruit production in two years.

4. Shorten the four canes retained for fruit production to eight buds each for weaker varieties and 10 to 12 buds each for stronger-growing varieties. This technique is an approximation of the balanced pruning concept suggested for commercial

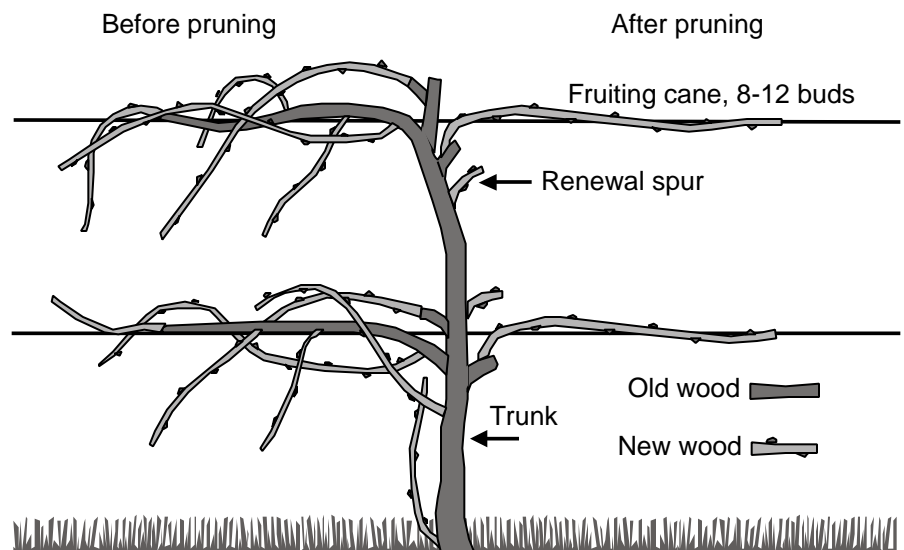

Diagram 14. 4-Cane Kniffin System, Mature Vine

vineyards. If desired, the balanced pruning concept, described later in this publication, may be used for more precisely determining the optimum bud number.

Umbrella Kniffin

The umbrella Kniffin system (*Diagram 15*) is a modification of the 4-cane Kniffin system. It is a head-training system suggested for vigorous varieties where more of the fruiting area is exposed to sunlight than would be the case in the 4-cane Kniffin system.

At planting, vines are handled as previously discussed. The trunk should be headed about 6 to 12 inches below the top wire. Two to six canes having eight to 15 buds each arising from the head (or heads) of each vine are selected. Each cane is bent sharply over the top wire and is extended down to the lower wire, where it is tied. Approximately the same number of renewal spurs as canes are left. The renewal spurs should be left near the head of the vines. Arms at the head of a mature umbrella-Kniffin are usually kept at least 1 foot or more in length.

Hudson River Umbrella

The Hudson River umbrella system (*Diagram 16*) is a modification of the Umbrella Kniffin system where the arms extend along the top wire halfway to the next vine. These arms, now called cordons, will live and bear fruiting spurs for several years. Spurs arise along cordons and

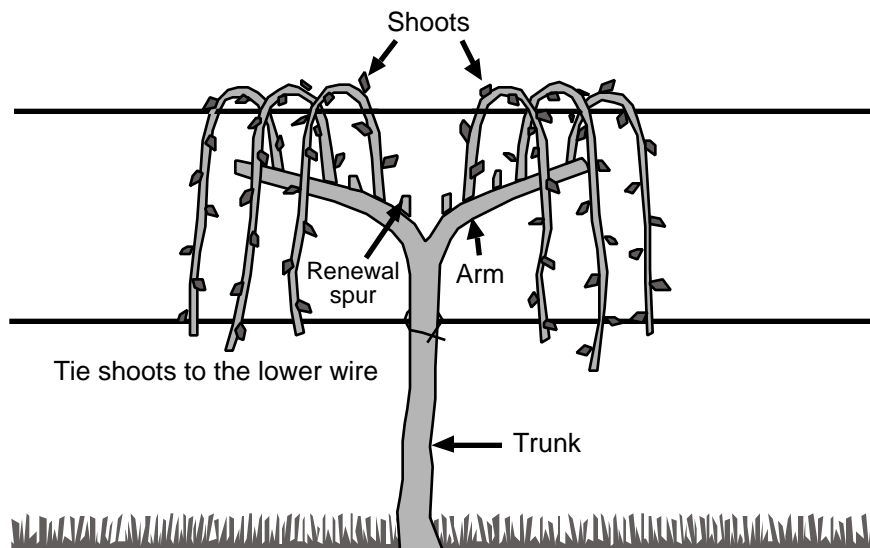

Diagram 15. Umbrella Kniffin

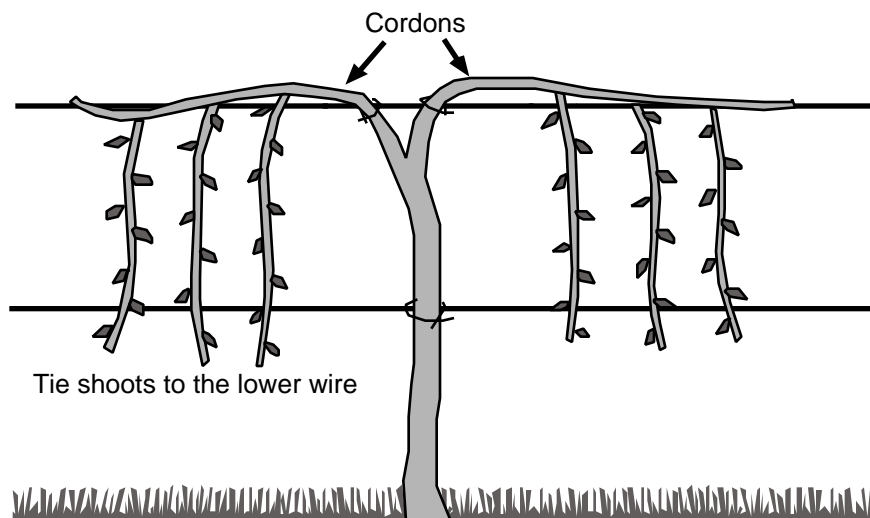

Diagram 16. Hudson River Umbrella

shoots that grow from buds on the spurs are directed vertically downward and tied to the lower wire. At pruning, head shoots (now called canes) back to three to four bud spurs. Remove some spurs directly at the cordon to stimulate development of new growth directly off the cordons.

Bilateral cordon

Some types of grapes have a downward growth habit, while other types grow up. The cordon

support wire on downward growing grapes should be positioned at 6 feet aboveground. The lower wire of the vertical trellis would serve as a trunk support wire and a catch wire for new shoot growth (*Diagram 6A*). With the upright growing grapes, the wire that will support the cordon should be about 3 feet aboveground. Wires above this level may be used as “catch wires” to support new shoot growth (*Diagram 6B*). Catch wires are

used to position shoots. They aid in maintaining a narrow canopy to facilitate good light penetration throughout the canopy and to keep the drive areas between rows free of obstructions.

The developing trunk(s) should be headed to promote lateral branching about 4 to 6 inches below the trellis wire that will support the cordon (*Diagram 17*). A single shoot should be trained to this trellis wire in each direction from the trunk to within

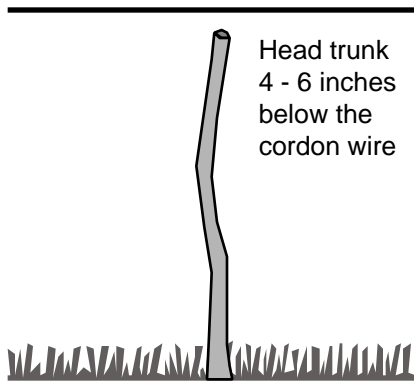

Diagram 17.
Bilateral Cordon System
First Dormant Pruning

about 12 inches of the shoot on the adjacent vine. This shoot will be retained for several years and will be referred to as a cordon in subsequent years. Cordons should be renewed every six to eight years.

Annual pruning of mature vines trained to this system (*Diagram 18*) involves elimination of old spurs and canes and selection of new shoots to be pruned back to spurs arising directly from the cordons. For upright-growing grapes, develop the spurs on the upper 180 degrees of the cordon (*Diagram 6B*). For downward-growing grapes, select

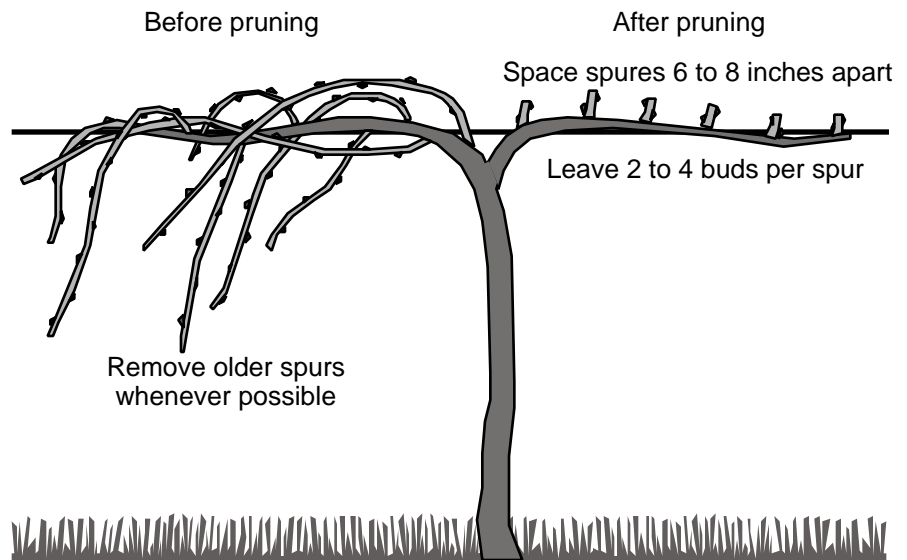

Diagram 18. Spur Pruning Grapevines

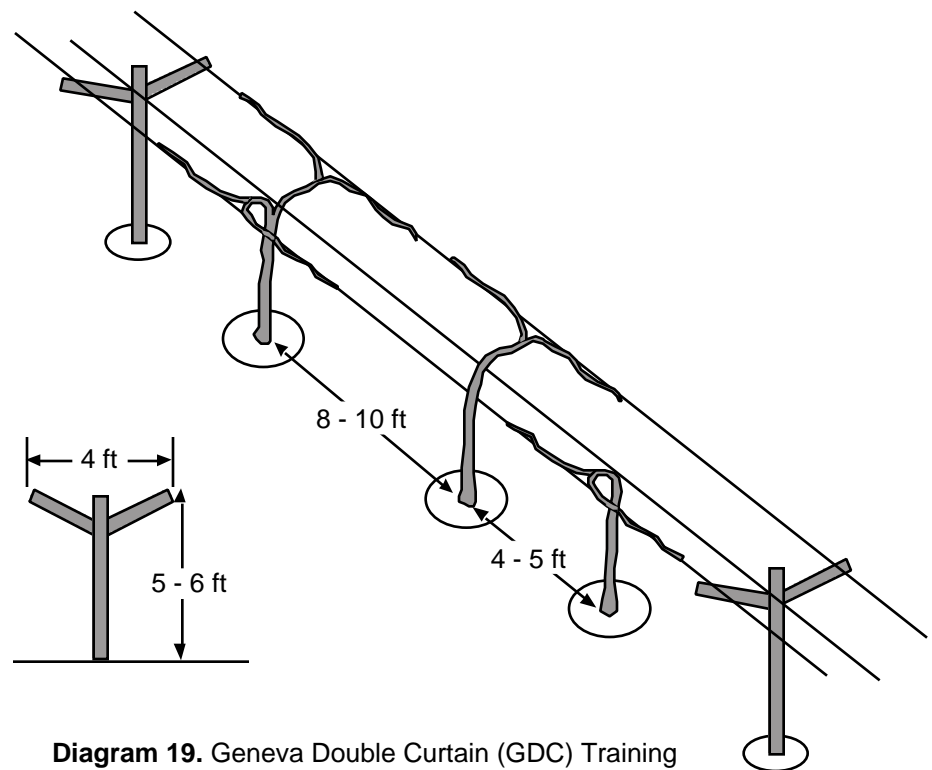

Diagram 19. Geneva Double Curtain (GDC) Training

spurs in the lower 180 degrees of the cordon (*diagram 6A*). Space spurs 6 to 8 inches apart on the cordons. Do not develop a spur at the bend of a cordon between the trunk and the wire, as it will tend to be overly vigorous and shade

adjacent spurs. Shoots to be used for spurs should be pruned back to two to four buds in length, depending on grape variety. In subsequent years, if new shoots grow directly off the cordons, develop some of them into spurs

and prune off adjacent older spurs at the cordon.

The number of spurs, the distance between spurs and the number of buds left on each spur at pruning depends on the type, the variety and the vigor of the grape.

Horizontal trellis systems

Geneva Double Curtain (GDC)

When properly maintained, the Geneva Double Curtain system (*Diagram 19*) exposes more fruit and foliage to sunlight than many other systems. It covers a greater percentage of land area with foliage and fruit than other training systems. GDC offers a way to double the cordon length per vine, while maintaining good sunlight exposure throughout the canopy, a real benefit for vigorous varieties. Two trunks may be developed per vine, with each trunk being trained to opposite cordon wires, or a single trunk can be split below the low wire by heading the trunk 6 to 12 inches below the wire and then training shoots arising on the trunk to opposite wires. These wires should be 4 feet apart to allow for sunlight penetration between the canes or cordons trained on them throughout the growing season. When each trunk reaches the appropriate wire, it should be headed to encourage lateral shoot development. One shoot should be trained in each direction. For less vigorous varieties, train vines to alternate sides and develop only two cordons per vine.

Cane renewal (cane replacement) or spur pruning may

be done on the wires. Annual cane renewal pruning involves removing those that bore the previous year's crop, selecting canes arising on the trunk near the wire and training one of them in each direction on the wire for the next crop. These canes will need to be adjusted for bud number. Select two more canes arising near the point where the trunk intersects the wire and prune them back to two buds. These "renewal spurs" will be the source of new shoots, some of which will be selected for fruit production the following year. If vines are to be spur-pruned, cordons will be developed on the wires in the same manner as described for the bilateral cordon system. Select 10 to 12 equally spaced, downward-growing, short shoots and prune them back to spurs from which fruit and shoots will develop. As with the bilateral cordon system, spurs that bore fruit should be removed and new shoots arising directly from cordons should be selected for pruning back to spurs each year.

Pruning Bearing Vines:

Regardless of the training system and trellis used, the steps used in pruning mature grapevines are similar:

1. With the exception of trunks and possibly cordons, remove all wood that is older than one year.
2. Select canes or spurs for next year's crop and for renewal spurs. Remove all others.
3. Adjust the length of remaining canes or spurs to the desired number of buds.

Once an area on a cane or spur has fruited, it will never fruit in that same region again. Instead, future yields will be borne on lateral shoots and extension growth. Therefore, regardless of the type of pruning conducted, an important goal is to remove old wood that has already fruited and to select canes or spurs arising directly off the trunk, renewal spurs or cordons for the next crop. The further clusters develop away from the main framework of the vine, the poorer the size and quality of the clusters will be and the thicker the canopy will be, thus limiting light, air and spray penetration throughout the canopy. New canes to be selected for fruiting have smooth bark that is often bronze-colored, with prominent buds. Older wood will have gray, shaggy bark and no buds (*Diagram 20*).

Balanced Pruning

The objective of pruning is to obtain consistently large crops of high-quality fruit. Perhaps the key word in this statement is "consistently." How much pruning should be done varies with grape variety, soil type, fertilizer applications, water and several other factors. The balanced pruning concept was developed by researchers at Cornell University to aid in attaining this objective.

With balanced pruning, a grapevine is pruned back, leaving the maximum number of buds suggested for that variety depending on its growth the previous summer. The prunings

New Wood (Canes)



Prominent buds, smooth bark (often bronze color)

Old Wood



Gray, shaggy bark and no visible buds

Diagram 20. New Wood versus Old Wood on Grapevines

that grew the previous year are weighed and this figure is then used to refine the number of buds to be left. For example, according to Table 2, Concord should have a maximum of 60 buds on vines set 8 feet apart. For the first pound of cane prunings, 30 buds should be left. For each additional pound of prunings, 10 more buds should be left, up to a maximum of 60 buds. While weighing prunings sounds like a tedious undertaking, it won't

Table 2			
Number of buds to retain for fruiting			
Grape variety	First pound of cane prunings	Each additional pound of cane prunings	Maximum number of buds per vine at 8 ft. spacing
American Bunch- Concord Fredonia	30 plus 40 plus	10 10	60 70
Niagara Delaware Catawba	25 plus " "	10 " "	60 " "
French-American hybrids - Small-clustered varieties such as Foch and Leon Millot	20 plus	10	50
Medium-clustered varieties such as Aurore, Cascade and Chelois	10 plus	10	40
Large-clustered varieties such as Seyval, DeChaunac and Chancellor	20 plus	10	45
Vinifera varieties (prune after growth has begun)	20 plus	20	60

take long before you can estimate pruning weights and forego weighing on a regular basis. Be sure to weigh only the prunings from the previous year's growth.

Overcropping, which may also be regarded as underpruning, results in small clusters and small berries. High levels of shade will result in poorer-quality fruit and increased pest pressures due to poor light, air and spray penetration. Vines weakened by the excessive crop become more susceptible to cold injury and may not initiate enough fruit buds for the next year's crop.

Overpruning (undercropping) leaves too few buds to give a good crop. Bull canes (very vigorous canes) are more susceptible to cold injury than canes growing at more modest rates. The high vigor causes heavy shading, with an inevitable decrease in fruit quality and increase in pest pressure. Also, since the distance between buds increases with increasing cane vigor, it may be impossible to retain the desired number of buds while keeping canes within their allotted space.

Weak vines should not be allowed to carry a heavy crop, as fruiting can be an exhaustive process. It is advisable to retain at least 15 to 18 nodes on a weak vine and then remove all clusters as soon as they begin to develop, as opposed to pruning vines back to just a few nodes.

Time to prune

Pruning in fall may interfere with the vine's ability to harden off properly, thus increasing the potential for winter injury. The optimum time to prune grapevines is in late winter to early spring. When done at this time, vines will "bleed." Bleeding is not detrimental to vines. Pruning in late winter to early spring enables you to assess the extent of cold injury and prune it out.

Delayed pruning involves pruning after growth has started. Bud break begins on the ends of canes first and progresses toward the trunk. With both cane replacement and spur pruning, a portion of the cane will need to be removed to adjust bud number. By waiting to prune until 4 to 5 inches of new growth are present on the ends of canes, bud break in the area where fruiting is desired can be delayed by 10 to 14 days. This may be of merit in avoiding injury due to a late frost.

Double pruning may be used when time constraints in spring won't allow delayed pruning. It involves pruning out excess canes prior to bud break. Those to be retained for fruiting are either left alone or not pruned as far back as the ideal bud count would require. Then, after the remaining canes have attained 4 to 5 inches of new terminal growth, they should be pruned to the correct length. Bud break in the desired area will be delayed as a result.

If pruning is done before bud break, it is important to know how fruitful the variety is on secondary

buds to determine how close to the desired bud number to prune. Frosts or freezes may destroy a portion of the primary buds, leaving varieties that are not highly fruitful on secondary buds with the potential for a light crop. With varieties like Seyval, which tend to be quite fruitful on secondary buds, it is possible to prune to the final desired bud number. For varieties that are not highly fruitful on secondary buds, it may be advisable to leave 50 percent more buds than needed, in case cold injury reduces the number of surviving buds after pruning. If this is done and no bud kill occurs following pruning, vines should either be pruned again or cluster thinning must be used to adjust fruit load to the proper level.

Grapes have compound buds made up of primary, secondary and tertiary buds. The primary bud will break first and will have the greatest yield potential. It is also the bud most likely to be killed by spring frosts. If this should occur, the secondary bud will break and give rise to new shoots and blooms. Many grape varieties will produce a substantial crop from secondary buds. Most American varieties are not highly fruitful on secondary buds; however, several, but not all, French-American hybrid varieties are. Cayuga White is an example of a hybrid variety that is not highly fruitful on secondary buds. If the secondary buds are also killed, the tertiary buds may break and give rise to new vegetative growth. No grape varieties are fruitful on tertiary buds (*Diagram 21*).

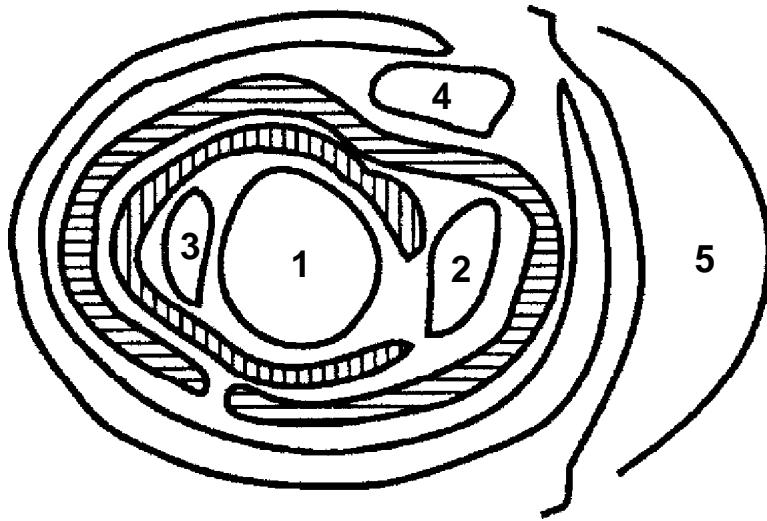

Diagram 21. Cross section of compound bud of Concord grape

1. Primary bud 2. Secondary bud 3. Tertiary bud 4. Lateral shoot 5. Leaf scar

Trunk Renewal

Damage to trunks by freezing, equipment contact, insects, diseases, etc. may lessen vine productivity over time. Trunk renewal will offset this problem. It is advisable to renew trunks on vines at least every 12 to 15 years, and perhaps more frequently where problems have occurred.

If a sucker arises at the base of a vine, do not prune it off. Instead, secure it to the trellis wires to keep it growing straight. Use the same training method as was employed in new plantings. Once the trunk has reached an acceptable height, cut off the old trunk during the dormant pruning and develop new canes from the replacement trunk (*Diagram 22*).

For vines with multiple trunks, stagger the time that trunks are renewed to reduce fluctuations in cropping. Also, since different age trunks may differ in their susceptibility to cold injury, the effect of this problem may be less devastating.

Pruning Neglected Vines

In some instances, vines that have been neglected for a period of years can be restored to a productive condition. However, if the period of neglect has been too long or if the vine has a lot of dead, diseased or insect-infested

wood, it may be better to destroy the old vine and plant a new, healthy vine. If the variety is unknown or no longer available, it may be possible to propagate new vines by taking cuttings or layering the old vine. Information of this procedure is given in the section on "Propagation."

Several characteristics are common with neglected vines. Fruit-bearing wood develops further away from the trunk.

Neglected vines may have a fair amount of dead wood. They will frequently have more than one trunk. Several steps should be taken when pruning such a vine.

First, remove any large, dead canes or cordons. This will make it easier to identify those that may be retained.

Second, inspect the trunks. If possible, cut off one or more of the trunks at ground level and remove them from the trellis. This will

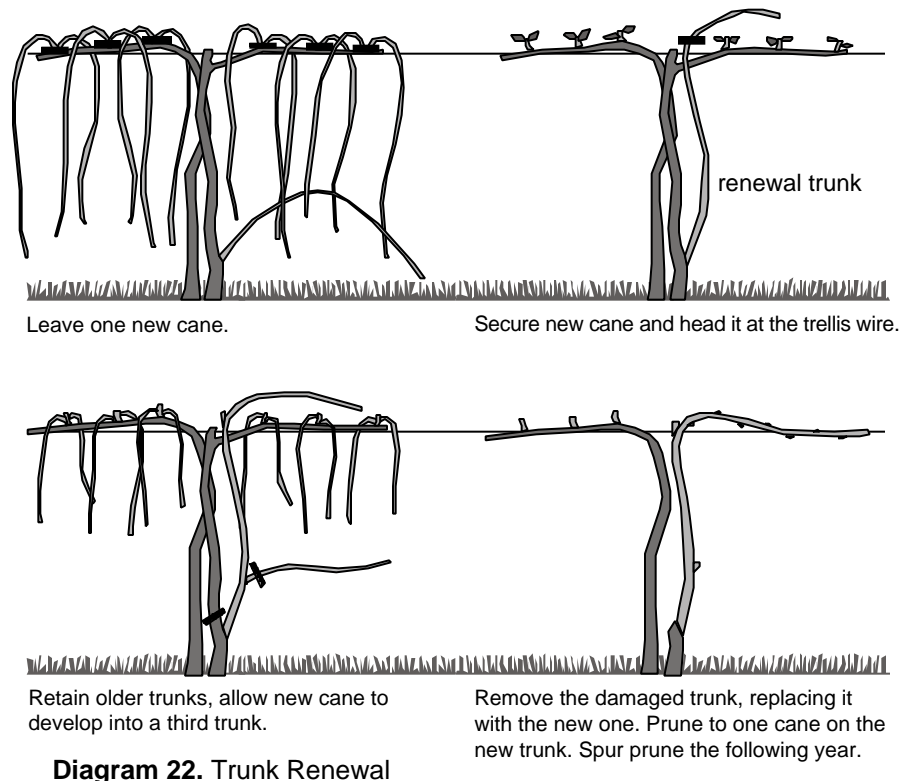

Diagram 22. Trunk Renewal

make decisions concerning the rest of the vine easier. Also, cutting a live trunk off at ground level may increase chances of getting a sucker to grow from below ground level. This sucker may be developed into a replacement trunk.

If healthy canes exist close to the trunk, cut off the cordons on the trellis wires and train the canes to the wires. Prune them back to the desired length. If no new healthy canes exist, select the best cordon on each side of the trunk for each trellis wire. Remove all other cordons. Spur-prune the cordons that are being retained. Develop canes closest to the trunk to replace cordons during the next dormant pruning.

Several years may be needed to renovate a vine that has been neglected. The overall objectives should be to eliminate dead, diseased or insect-infested wood, to gradually renew trunks and cordons and to develop the fruiting wood close to the trunk.

Once the vine has been renovated, annual pruning is essential to keep it productive.

Disposal of Prunings:

Prunings can either be chopped on the vineyard floor or removed from the planting. A flail mower can chop prunings into very small pieces and place them in contact with the soil, where they present very few problems with the carryover of insects or diseases. Rotary mowers do not chop prunings fine enough to reduce the reinfection or reinfestation

potential from diseased or insect-infested wood. If prunings are removed, do not stockpile them near the vineyard, as they will serve as a source of pest problems that will spread back into the vineyard. Burning prunings is probably the best way to deal with them, since it will eliminate insect and disease carryover problems.

Fertilizing and Liming

Grapevines will grow and fruit satisfactorily over a pH range of 5.5 to 7.0. Since the vines will be in place for many years and since it is difficult to modify the pH of the subsoil after planting, soil testing prior to planting is highly recommended. In a preplant situation, take a sample in the upper 8 inches of soil and a second sample at the 8- to 16-inch depth. If lime or nutrients are needed in the subsoil area, incorporate them at the recommended rates prior to planting.

For established vineyards, nitrogen may be the only element needing application on an annual basis, especially if attention was paid to the preplant soil test recommendations. Apply ammonium nitrate at the rate of 0.3 lb. or the equivalent in nitrogen from another source per vine in an area extending from 4 to 6 feet out from the trunk. If another fertilizer is to be used, be sure to make the necessary rate adjustment based upon the actual nitrogen content of the fertilizer. The amount of nitrogen may be adjusted depending on plant performance and cropping history in preceding

years. Low rates of fertilization may result in inadequate growth to support the plant and the developing crop. High rates will promote excessive growth and too much shade in the fruiting zone of the vine. The result will be poor-quality fruit and high disease pressure. Nitrogen application should be made in late winter to early spring prior to the resumption of growth.

Magnesium deficiency may occur in some vineyards. It appears as an interveinal chlorosis (yellowing of the leaf tissue between the leaf veins) beginning first on the basal leaves and progressing upward toward the younger leaves. The appearance of magnesium deficiency close to harvest is not a cause for alarm. However, if the problem shows up earlier in the growing season, steps should be taken to correct the problem. If the soil pH is below 5.5, an application of dolomitic limestone may correct the problem. Where the soil pH is above 5.5, consider spraying magnesium sulfate (epsom salts) at the rate of 16 lb. per 100 gallons of water using 200 gallons of spray per acre in each of two post-bloom sprays.

Information and supplies regarding soil testing are available at your county Extension office. Assistance in interpreting results of the soil test, if needed, may be obtained there as well.

Vineyard Floor Management: More Than Just Controlling Weeds

Weed control is an essential step in optimizing quality grape production and ensuring the long-term health of both the commercial and home vineyard. Grass weeds (like crabgrass and bermudagrass) and broadleaf weeds (like dandelion) compete heavily with the vines for growth requirements (such as water and nutrients). Controlling weeds under the vines directs the resources to the vines as well as facilitating good air drainage and eliminating sites for pest problems to develop. Weed control in the vineyard is best achieved by adopting a vineyard floor management program, including a continuous strip devoid

of vegetation under the vines plus a mowed sod strip between the rows and around the perimeter of the vineyard (*Diagram 23.*)

Each aspect of this management system provides certain benefits that optimizes the long-term health of the vineyard. Under the vines, maintaining the area devoid of vegetation provides the following benefits:

1. Elimination of competition from weeds for moisture and nutrients, thereby achieving greater growth rates, especially in new vines.
2. Minimize vole damage by preventing the buildup of a mulch layer under the vines. Grape vines can be damaged or killed by voles feeding on the roots and stem. Meadow voles, found in the northeastern part of

Tennessee, and prairie voles, found from the Cumberland Plateau west, live and feed on the top of the ground in the mulch layer. Thus, maintaining the vegetation-free strip eliminates protective cover, discouraging voles from inhabiting the area. Pine voles, which are found throughout the state, work underground, and therefore are not as easily discouraged. Firm, bare soil under vines will lessen their activity.

3. Minimize frost events. Firm, moist, bare soil absorbs more heat during the day than any other ground management system. Heat is reradiated from the soil at night over a longer time than with other floor management systems, thus

Diagram 23. Vineyard Floor Management Program

- 10 to 12 feet between rows
- 4-foot wide strip under vines free of vegetation
- 6 to 8-foot wide sod strip between rows

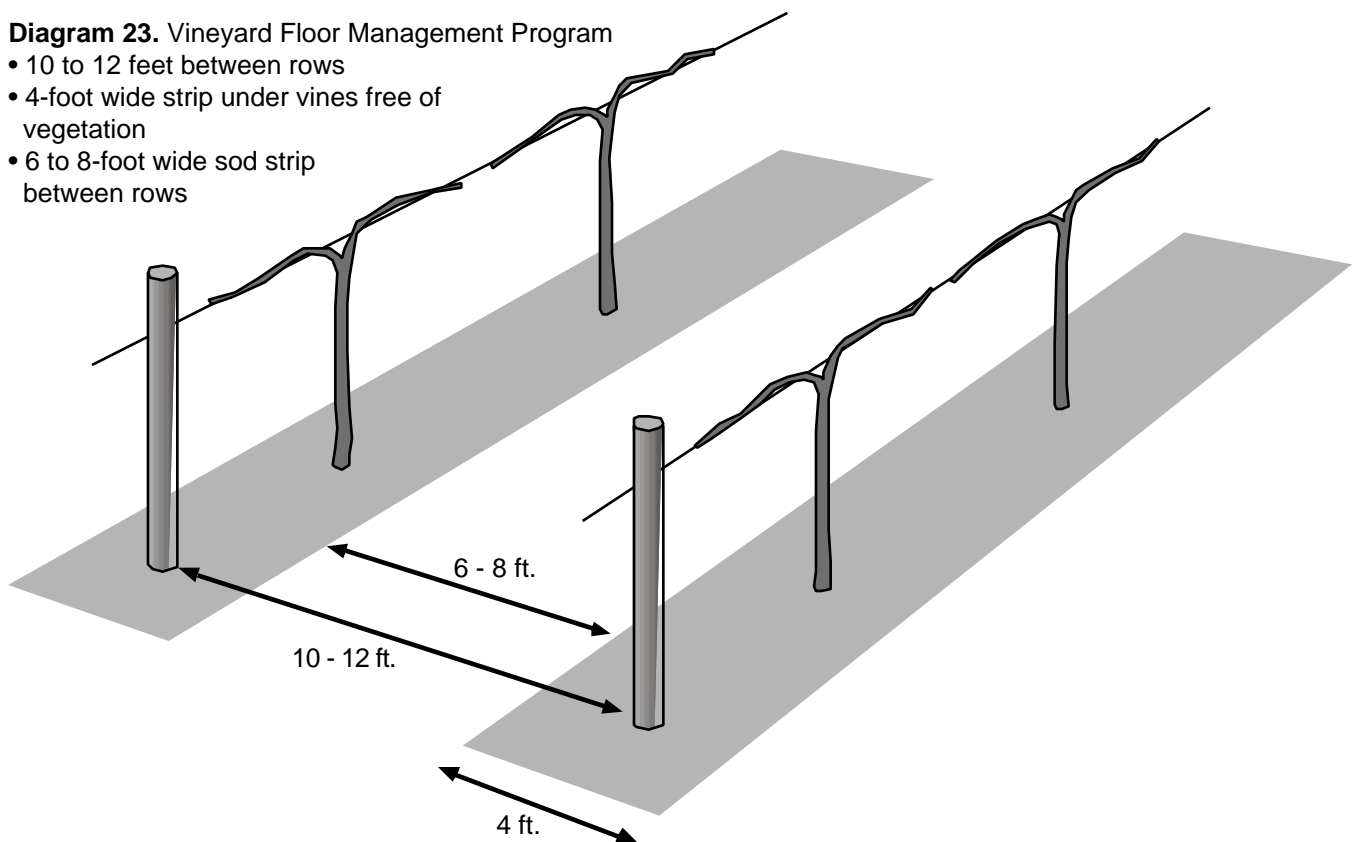

providing some additional protection from frost events. In addition, the absence of vegetation allows for improved cold air drainage, providing additional frost protection.

4. Minimize insect and diseases by lessening alternate host sites. Certain weeds provide an alternate host site for pests of grapes so their absence could result in a lessening of pressure from certain pests in the vineyard. The potential for problems with grape root borer can also be lessened by removing many of the egg-laying sites that weeds under vines provide. In addition, the presence of weeds decreases air movement, creating humidity pockets favorable for the development of certain diseases.

On sloping land, rows should be planted across slopes rather than up and down slopes. Maintaining a sod strip between rows provides the following benefits:

1. Serves as a diffusion and deceleration strip for runoff water, thereby minimizing soil erosion.
2. Supports equipment movement, especially in wet conditions.
3. Minimizes frost potential when closely mowed, as drainage of cold air is less restricted.
4. Minimizes vole habitat when closely mowed.

Between rows, a grass sod is probably the most desirable type of ground cover, since certain broadleaf ground covers and/or

weeds may serve as an alternate host to pests. Thus, grass sod is preferred. Ideally, the grass sod should be non-competitive, requiring minimal mowing. The fine fescues (red and hard fescue) are the least competitive, requiring less mowing compared to tall fescue. They also go dormant during the heat of the summer. However, seed for these grasses is more expensive than tall fescue and slow to establish (fall is the optimum establishment time), thereby leaving vineyard floors susceptible to erosion during establishment. Tall fescue is the dominant grass cover in most Tennessee vineyards.

Tall fescue seed is relatively inexpensive, readily available and quick to establish (if it is not already established in the site). Tall fescue supports equipment traffic well. However, tall fescue is competitive for water and nutrients and requires more frequent mowing during the growing season. If not controlled, it will provide favorable habitat for voles.

This vineyard floor management program can be achieved by following a few easy steps. Keep the sod mowed short between rows and around the perimeter of the vineyard. Within the row, maintain a 4-foot wide strip (2 feet each side of the vine) under the trellis free of vegetation. Weeds (broadleaves and grasses) can be controlled by mechanical means or with herbicides. Shallow cultivation under the vines can be used for control of annual weeds. In cherty soils, grape hoes or

rotovators may cause damage to the vines. Cultivating clay soils when they are too wet may result in formation of a shallow, compacted layer (or plow pan) that will limit root growth and restrict water movement to the roots. In addition, cultivation is also time-consuming and expensive. Herbicides provide the easiest, least expensive and most effective method of controlling annual and perennial weeds. Herbicides are safe when used properly, including being applied at the right amounts and the right times. Always read and follow the use directions for the herbicide product on the product label. Choice of herbicide and application timing may be dependent on the size of the vineyard being maintained.

Many herbicide selections are available for commercial vineyards. The best option may be a combination of herbicides. No one herbicide, applied one time at the recommended rates, will give year-long control. Thus, for season-long control, the best approach is two applications per year, using a combination of a non-selective herbicide (to control existing weeds) plus preemergence or residual herbicides (to slow the re-emergence of weeds). The ideal program includes an application in early winter (November - December) followed by a second application of a different herbicide combination (to limit development of herbicide-resistant weeds) applied in early summer prior to extensive vine growth that may interfere with uniform

application. For specific herbicide options, contact your county Agricultural Extension office or consult University of Tennessee Agricultural Extension Service publication PB1197, *“Commercial Small Fruit Spray Schedules”*. This publication is revised annually as herbicide products and directions for use change often.

In summary, vineyard floor management is more than just weed control. It is a vital part of an integrated vineyard management program that aids in optimizing the production of quality grapes and ensuring the long-term health of either the home or commercial vineyard.

Pest Control

Grapevines are vulnerable to attack from many pests. For most types of grapes, a spray program is necessary to produce fruit of acceptable quality and to maintain vine health. Two University of Tennessee Agricultural Extension Service publications, PB1622, *“Disease and Insect Control in Home Fruit Plantings,”* and PB1197, *“Commercial Small Fruit Spray Schedules,”* offer timely information concerning pest control in grapes and other fruit crops. These publications are available without charge at your county Extension office. When using pesticides, exercise caution and always follow label directions.

Many cultural practices will influence pest problems in vineyards. If possible, select a site that is more elevated than the immediate surroundings. This will

lessen the potential for frost injury and disease development. Factors favoring good air movement throughout the vineyard and sunlight penetration throughout the canopy of the vines, such as high trellises and good pruning practices, are invaluable for reducing pest pressures and increasing fruit quality. Proper fertilization practices to avoid weak vines or excessive growth rates will aid in avoiding pest problems. Vineyard sanitation, including raking leaves, elimination of mummified fruit and removal of prunings will lessen pest pressures the following growing season.

Birds have become a major pest problem in many home and commercial vineyards. Results using aluminum pie pans suspended in the vineyard and plastic snakes on the vines, as well as several other practices, have been erratic. Netting the vines is the only sure way to keep birds away. Nets should be put on before bird pressure gets heavy. The net should completely enclose the vines and either be tied under the vines or anchored to the ground to prevent birds from getting under it. If possible, suspend the netting above the vines, possibly by extending another wire horizontally above the vines. This will keep the vines from growing through the netting. With care, netting can last for several years.

Yellow jackets, bees and wasps do not reduce yields very much. However, they do cause problems during harvest.

Insecticides that may be effective against them have a relatively long waiting period following application. Therefore, they cannot be used shortly before harvest. Removal of damaged fruit from the vineyard before these pests become a problem helps to reduce the intensity of the problem. Harvested fruit should not be left setting in the vineyard, as bees and wasps will be attracted to it. Elimination of nests prior to fruit ripening may reduce activity in the vineyard. However, location and destruction of the nests may be very difficult.

Estimating Yields in Vineyards

Having a fairly accurate estimate of yield prior to harvest enables growers to make marketing arrangements for their crop. It helps winery managers to know whether they will have a sufficient supply of fruit from their regular growers or if they will need to investigate other sources of grapes for the upcoming crush. Early crop estimates can be used by growers to determine if vines are being overcropped or undercropped. If estimates are developed early, cluster thinning may be used to lessen the stress of overcropping.

Yields will vary from year to year due to environmental factors and cultural practices. Therefore, crop estimates should be developed annually. The accuracy of the estimates will be determined by the numbers used in making the necessary calculations. Since

weather conditions, pest pressures and other factors will influence the development of the crop following the time that estimates are made, expect some differences between the estimates and the actual yield. Using accurate, precise information wherever possible in developing the estimates will increase the reliability of the crop estimates.

Developing accurate crop estimates involves a thorough knowledge of the vineyard and growing conditions plus an accumulation of information from previous years. Crop estimates are based on good records of average cluster weights at harvest, an accurate count of the current living vines in an acre or block, and an

accurate determination of the average number of clusters per vine at the time the estimate is being made.

Factors influencing cluster weight include:

- flowers per cluster
- berries per flower (percent fruit set)
- seeds per berry
- weight of fruit per seed

Variations in cluster weight are influenced by the percent of flowers that set. Cloudy, rainy weather during or immediately following bloom, poor vine nutrition and foliar damage from pests all will result in reduced cluster weights.

The number of clusters on a given area will vary from year to year depending on:

- number of vines (vine loss over time)
- number of nodes per vine (dormant pruning severity)
- number of shoots per node (varies with variety, vine vigor and the amount of shoot thinning used)
- clusters per shoot (affected by variety, degree of bud injury, growing conditions for the vine during the previous growing season. Shoots growing in heavy shade are more likely to have nodes with less fruitful shoots the following year.

Use the formula below to estimate yield:

Estimated Yield (pounds)/vine = (# of clusters/vine) x (average cluster weight)

To get the yield estimate for several vines, simply multiply the estimated yield per vine by the number of vines.

Commercial growers will want to modify the formula as shown below to get an estimate of tons per acre:

Estimated Yield (tons/acre) = (# bearing vines/acre) x (clusters/vine) x (average cluster weight in pounds) divided by 2000.

Clusters/vine may either be counted or calculated by multiplying the number of shoots per vine by the number of clusters per shoot.

The number of bearing vines per acre may be calculated using the following formula:

$$\text{Bearing vines/acre} = \frac{(\text{in-row spacing} \times \text{between row spacing})}{43,560 \text{ (square feet in an acre)}} - \text{missing vines in the acre}$$

or use the following chart if the vine spacings in your vineyard are listed:

distance between vines	distance between rows	vines/acre
6 feet	10 feet	726
	12 feet	605
8 feet	10 feet	545
	12 feet	454
10 feet	10 feet	436
	12 feet	363

Be sure to subtract the number of missing vines in the acre to give a more precise yield estimate.

The number of clusters per vine may be calculated by multiplying the **number of shoots per vine** by the **number of clusters per shoot**. The reliability of the average cluster per vine count increases as more vines are included in the count.

Crop estimates can be made any time after all the flower clusters are exposed on a developing shoot. However, waiting until after fruit set enables you to calculate percent berry set, giving a more accurate count.

Vines to be used in making cluster counts should be selected throughout the planting. The more vines that are counted, the more accurate the count will be. How many vines to count will depend on the size of the vineyard and the uniformity of the vines. For a one- to two-acre vineyard with vines of a uniform age, size and training system, only 10 to 15 vines may need to be sampled. In a larger vineyard where the vines may not be uniform, separate the vineyard into several uniform blocks and make counts from each block.

Average cluster weight should be determined at harvest each year. This number should then be included in an average for all the years in which cluster weights have been recorded. Determine the average cluster weight for each variety and each block for all the years over which data has been obtained. The more years involved in developing the average, the more accurate the average will be. Instead of randomly selecting clusters to be

weighed, select the vines, count the number of clusters on the vine, harvest the fruit and weigh it, being sure to subtract the weight of the container. Then calculate the average weight per cluster for that vine.

Factors between sampling time and harvest (i.e. amount of rainfall, pest pressure, bird damage, deer damage, etc.), are not constant from year to year. Therefore, using averages calculated from just one year's crop can be misleading.

Estimates of yield are just that — estimates. Hopefully, the estimate you arrive at will be within 10 to 15 percent of the actual yield. The following tips will help to increase the accuracy of the estimates:

1. Accumulate average cluster weight data over a period of years instead of just one year. Actual cluster weights from each harvest should be figured into the average.
2. Develop cluster weights from your own vineyard. Do not rely on those from other areas.
3. Sample the entire vine to get the average cluster weight for that vine.
4. Divide non-uniform blocks into smaller, uniform sub-blocks and sample each of them separately.
5. Sample each variety separately.
6. The same person should develop crop estimates each year to further reduce variation.

Harvesting

Grapes will not increase in color or sugar level after harvest, so it is essential to allow them to attain the desired level of maturity prior to harvest. Berry color should not be used as an indicator of maturity, since the color change can occur well in advance of ripening.

As grapes ripen, the sugar level of the berries will increase, juice pH will increase and total acidity will decrease. The seeds will turn from green to brown and will separate easily from the pulp. The stem of the cluster will turn brownish and become slightly wrinkled.

The best time to harvest will depend on the intended use for the grapes. For jelly, grapes should be picked somewhat early to get a light, clear jelly that will be free of crystals. Table grapes are picked when seeds have turned brown and flavor is at its peak and before clusters begin to shatter (berries start to drop). Wine grapes should be harvested when sugar levels, juice pH and total acidity have reached desired levels. These levels may vary depending on the type of wine to be made.

Uneven ripening of entire clusters or of berries in clusters may be a problem some years. Weather stresses such as frosts or freezes may damage some primary buds (*Diagram 21*). In many varieties, secondary bud break will occur after clusters from primary buds have already started to develop. When clusters from the primary buds are ready to be

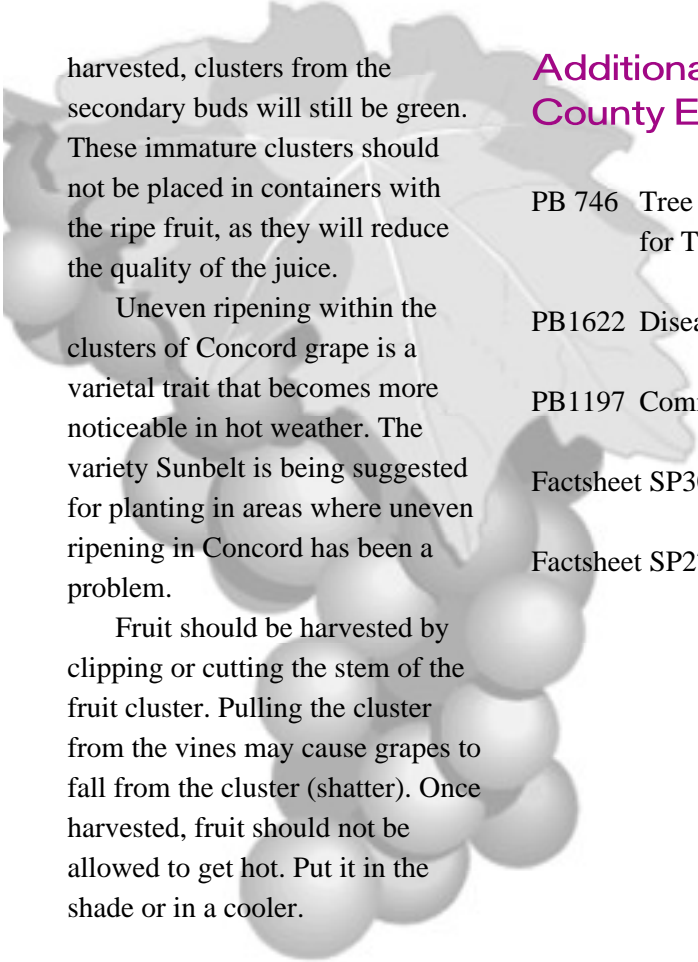

harvested, clusters from the secondary buds will still be green. These immature clusters should not be placed in containers with the ripe fruit, as they will reduce the quality of the juice.

Uneven ripening within the clusters of Concord grape is a varietal trait that becomes more noticeable in hot weather. The variety Sunbelt is being suggested for planting in areas where uneven ripening in Concord has been a problem.

Fruit should be harvested by clipping or cutting the stem of the fruit cluster. Pulling the cluster from the vines may cause grapes to fall from the cluster (shatter). Once harvested, fruit should not be allowed to get hot. Put it in the shade or in a cooler.

Storage

Most grape varieties grown in Eastern states cannot be stored for very long periods of time. As a rule, red varieties store longer than blue-black or white varieties. The ideal conditions for grape storage include temperatures of 30 to 33F and relative humidity of 85 to 90 percent. Refrigerators generally run about 40F and at low humidity levels. While this temperature is close to ideal, moisture loss from the fruit will be excessive if the fruit is not sealed in plastic bags.

Additional References Available at Your County Extension Office

PB 746 Tree Fruit, Tree Nut and Small Fruit Cultivar Recommendations for Tennessee

PB1622 Disease and Insect Control in Home Fruit Plantings

PB1197 Commercial Fruit Spray Schedules

Factsheet SP307N Selecting Quality Grapes

Factsheet SP277J Black Rot of Grapes

PB1475-4M-03/01
E12-5215-00-005-01

The Agricultural Extension Service offers its programs to all eligible persons regardless of race, religion, color, national origin, sex, age, disability or veteran status and is an Equal Opportunity Employer. COOPERATIVE EXTENSION WORK IN AGRICULTURE AND HOME ECONOMICS. The University of Tennessee Institute of Agriculture, U.S. Department of Agriculture and county governments cooperating in furtherance of Acts of May 8 and June 30, 1914. Agricultural Extension Service, Charles L. Norman, Dean